

Global Network

— The Thermal Solution Company —

HISAKA provides thermal solutions based on our core technologies of the plate heat exchanger to all customers in the world.

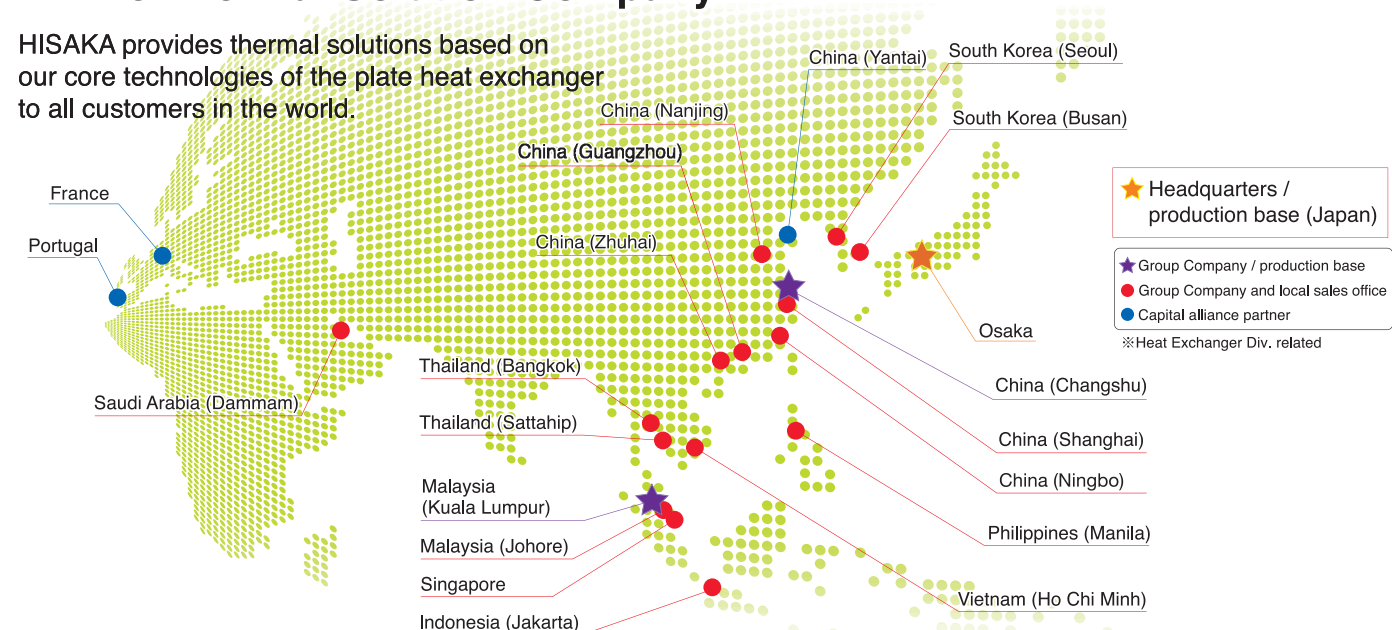

Hisaka Group

■ **Malaysia**
HISAKAWORKS S.E.A. SDN. BHD.
KUALA LUMPUR
 TEL : +60-3-8081-4185 FAX : +60-3-8081-7185
JOHOR BRANCH
 TEL : +60-16-228-4209

■ **Thailand**
HISAKA WORKS (THAILAND) CO., LTD.
BANGKOK
 TEL : +66-2-744-3287 FAX : +66-2-744-3286

SATTAHIP SALES OFFICE
 TEL : +66-3-819-9819 FAX : +66-3-819-9820

■ **Singapore**
HISAKAWORKS SINGAPORE PTE. LTD.
 TEL : +65-6-897-8489 FAX : +65-6-686-4579

■ **Indonesia**
PT. HISAKA WORKS INDONESIA
JAKARTA
 TEL : +62-21-2931-9235

■ **Vietnam**
HISAVINA Ho Chi Minh (Representative Office of HISAKAWORKS S.E.A. SDN. BHD.)
 TEL : +84-8-3910-7355 FAX : +84-8-3910-7356

■ **Philippines**
HISAPINO Manila (Representative Office of HISAKAWORKS S.E.A. SDN. BHD.)
 TEL : +63-2-224-4129 FAX : +63-2-224-4130

■ **South Korea**
HISAKA KOREA CO., LTD.
SEOUL
 TEL : +82-2-739-8861 FAX : +82-2-739-8864

BUSAN BRANCH
 TEL : +82-51-747-0265 FAX : +82-51-747-0266

■ **China**
HISAKA WORKS (CHINA) CO., LTD.
CHANGSHU
 TEL : +86-512-5213-3000 FAX : +86-512-5213-3008

SHANGHAI BRANCH
 TEL : +86-21-5211-0701 FAX : +86-21-5211-0720

GUANGZHOU BRANCH
 TEL : +86-20-3810-5515 FAX : +86-20-3847-7539

NANJING SALES OFFICE
ZHUHAI SALES OFFICE
NINGBO SALES OFFICE

■ **Saudi Arabia**
HISAKA MIDDLE EAST CO., LTD.
DAMMAM
 TEL : +966-13-838-4700 FAX : +966-13-838-5800

● **Capital alliance partner**
ARSOPI THERMAL S.A. (Portugal)
 TEL : +351-256-410-410 FAX : +351-256-410-411
Yantai Shinwa Joining Technology Co., Ltd. (China)
 TEL : +86-535-643-3939 FAX : +86-535-643-3926
KAPP SAS (France)
 TEL : +33-4-78-05-68-68

HISAKA WORKS, LTD. Heat Exchanger Division

Sales Department

Osaka: Sonezaki, Kita-ku, Osaka-shi, Osaka, 530-0057, Japan
 TEL: +81-6-6363-0020 FAX: +81-6-6363-0161

Tokyo: Kyobashi, Chuo-ku, Tokyo, 104-0031, Japan
 TEL: +81-03-5250-0760 FAX: +81-3-3562-2759

Hokkaido: 6-1-20, Higashisapporo 3jo, Shiroishi-ku, Sapporo City, Hokkaido 003-0003 Japan
 TEL: +81-11-868-8010 FAX: +81-11-868-8011

Chiba: 1-23-6, Goichuonishi, Ichihara City, Chiba 290-0081 Japan
 TEL: +81-436-24-3322 FAX: +81-436-24-3323

Nagoya: Sakae, Naka-ku, Nagoya-shi, Aichi, 460-0008, Japan
 TEL: +81-52-217-2491 FAX: +81-52-217-2494

Customer Service: 2-1-48, Higashi-konoike-cho, Higashi-osaka-shi, Osaka, 578-0973, Japan
 TEL: +81-72-966-9601 FAX: +81-72-966-8923
 URL: <https://www.hisaka.co.jp/english/phe/>



— Create the future with heat
The Thermal Solution Company

HISAKA provides thermal solutions based on our technologies of the plate heat exchanger to all HISAKA fans in the world.

HISAKA WORKS, LTD., Heat Exchanger Division is both ISO9001 and ISO14001 certified.
 HISAKA WORKS, LTD., Konoike Plant is ISO45001 certified.

No part of this brochure may be used, cited, or altered for any purpose or reproduced in any form without the prior written permission of the copyright holder. All product details, including appearance and specifications, presented in this brochure are subject to change for improvement without prior notice.

Agent

HE-CE004704
 22.03. SAN

— Create the future with heat
The Thermal Solution Company

HISAKA MAINTENANCE SERVICE



HISAKA

Heat Exchanger Division

“Kitto”

Sure to fit your applications by excellent performance

“Motto”

More applications by versatile products line up

“Zutto”

Longer life time by high quality maintenance service

**HISAKA will continue to supply
such reliable Plate Heat Exchanger.**



Maintenance Concept

Since becoming the first Japanese manufacturer of commercial plate heat exchangers (PHEs) in 1955, HISAKA WORKS has taken full advantage of state-of-the-art plate technology and manufacturing facilities to develop and provide a variety of products that meet the needs of various industries.

In order to provide total customer satisfaction as a top manufacturer of PHEs, and to maintain product performance across the total life cycle of PHEs, Hisaka provides a maintenance menu of various products and services, which also includes a Full Service Package. We make the best use of the know-how we have cultivated while achieving top market share in Japan, to "rapidly" provide "relief and reliance" with "reasonable" service contents as a maintenance service supporter.





Trouble and Solutions



Maintenance Service Program

PHEs rarely experience failure or trouble, because they have no moving parts and few component parts. However, if they are used for long years, problems such as gasket deterioration, scaling, and cracking on the plates can occur.



If you operate without maintenance, the following problems can occur:

- ① Leakage due to aging and deterioration of gaskets
- ② Reduction in heat transfer performance due to scaling on the plates
- ③ Contamination due to cracks or pinholes caused by corrosion on the plates

In addition, the following risks can arise if you perform maintenance yourself:

- ① Remaining scale due to incomplete cleaning of the plates
- ② Oversight of signs of corrosion / cracks / pinholes
- ③ Plate damage due to excessive tightening
- ④ Incorrect plates assembly

As a manufacturer of PHEs, HISAKA offers comprehensive maintenance service program based on know-how accumulated over many years.

	Types of Trouble	On-Site Maintenance (Customer's Location)	Off-Site Maintenance (Full Service Package)
① Decreasing of Performance	 <p>Increase in a pressure drop and decreasing in heat transfer performance due to scaling</p>	Restored through disassembly and cleaning, or CIP (Cleaning In Place) by chemical agents	The unit is taken off site for a "Full Service Package" at our service center. Gaskets and other consumable parts are replaced, for complete restoration of the unit.
② Fluid Leakage	 <p>Leakage of fluid due to deterioration or hardening of rubber gaskets</p>	To stop the leakage by regasketing	
③ Mixing of Two Fluids	 <p>Contamination (mixing of two liquids) due to pinholes or cracks</p>	Replacement with a new plate to stop the contamination	

* Depending on the condition of the product, on-site maintenance might result in a lower level of restoration than could be achieved through off-site maintenance.

Full Service Package (Off-Site Maintenance)

①

① Whole PHE Unit

We take the entire PHE unit back to our service center for maintenance.

② Plates Only

We take only the plates back to our service center for maintenance.

To page 6

Maintenance at Customer's Site (On-Site Maintenance)

②

① On-Site Maintenance

Our service engineers perform maintenance at the customer's location.

② CIP (Cleaning In Place)

This maintenance recovers the performance of PHEs through circulation with chemical agents.

To page 8

Sales of Maintenance Parts

③

We provide spare parts for PHEs.

To page 10

Other Service Options

④

① Performance Check Service

This service allows visualization of the performance of PHEs currently in use.

② Plate Re-Pressing

Re-Pressing to modify the deformation of the plates.

To page 11

⑤

Plate Rotation

We provide a plate replacement service, rotating out your current plates and maintained plates that we keep in storage.

To page 12



Full Service Package Menu



Advantages of the Full Service Package

Maintenance work by a top PHE supplier provides longer life time for all brand

HISAKA's Full Service Package restores PHEs which are manufactured by not only HISAKA but other suppliers, and requires no work by the customer. Many repeaters have evaluated this service highly.



"Arattaro" Promotional character



Full Service Package for Whole Units

The Full Service Package is a total maintenance service in HISAKA. PHE disassembly, visual checks of plates, cleaning, regasketing, frame repairs, assembly, and final inspection are all performed by service centers, for the best possible performance and a long operating life time for PHEs.



Full Service Package for Plates

If a unit is installed in a location where it cannot be moved, HISAKA also provides a Full Service Package for the plates only. After maintenance is performed on the plates, a pressure test using a frame is performed to confirm that the plates do not leak before they are shipped back.



Return Containers for Full Service Package

Return containers that precisely fit the plates that are currently in use are provided upon customers' requests. Simply send us the plates in the return containers, and we will send back cleaned plates.

Plate Disassembly and Pickup Service

We disassemble your PHE on site, and then reassemble it on site after maintenance.



Service Truck

Maintenance Menu Comparison

Assessments of off-site and on-site maintenance are shown in the following table. Please select the service that best fits your actual maintenance needs.

	Disassembly	Cleaning Result	Regasketing	Working Hours	Working Place
Full Service Package	Yes	Very good	Yes (depends on condition)	7 days or more	Off-site
On-Site Maintenance	Yes	Bad to Good	Yes (depends on condition)	Depends on model	On-site
CIP	No	Bad to Very good	No	About 2 days	On-site

Advantages of the Full Service Package

Merit 1
Shorter Maintenance Time

Leaks in PHEs are caused by deteriorated gaskets. Maintenance that is difficult to perform on site, such as units with a large number of plates or large size units, can be performed rapidly in our service center, improving the efficiency of the customer's maintenance work.

Merit 2
Complete Recovery of Performance

Sometimes it can be difficult to completely remove scale. Further, using excessive force when removing the scale can result in deformed or damaged plates. Skilled personnel use specialized technology and equipment to completely remove scale from plates, and restore heat transfer performance to the best possible condition.

Merit 3
Reliable and Stable Operation

It might be difficult to find small corrosion and tiny pinholes in plates. Our skilled professionals can quickly find defects on the plates. If frame repairs are required, HISAKA can supply any parts of frames because of a manufacturer of PHEs.

Merit 4
More convenient maintenance service

All of your PHEs can be maintained by single maintenance partner.

Merit 5
Less Waste Water at Customer Site

The waste water by cleaning the plates with a variety of fluids is also treated at our service centers, reducing the waste water on the customer site.

Flowchart of the Full Service Package

The Full Service Package is a service in our maintenance menu for keeping PHEs in the best possible condition.

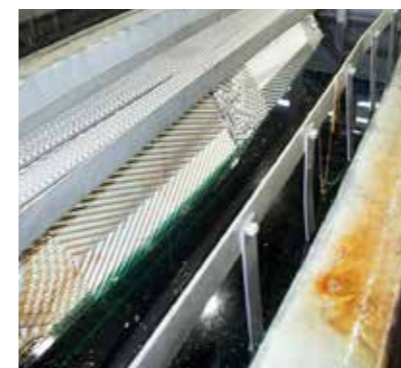

Soaking in degreasing tank and cleaning tank

After washing, grease and scale on plates are removed in these tanks. At the same time, gaskets and the adhesive are also removed.



Water jet cleaning

Water jet cleaning is performed to remove hard scale that could not be removed in the tanks. Even more hard scale is scrubbed off with brushes.



Inspection

After maintenance is complete, the plates are assembled in frames and tightened to the required specifications. A pressure test is performed before shipping.



Maintenance at Customer's Site ①

In cases where use of the Full Service Package is not available, HISAKA will send skilled service engineers for on-site maintenance.

On-Site Maintenance

HISAKA can send skilled service engineers to perform maintenance work at the customer's site. We use specialized tools, such as automatic tightening devices to efficiently disassemble and assemble the PHE and high temperature hot water jet cleaning to remove sticky oil residues, to provide high quality maintenance service at the customer's site.



On-Site Maintenance



Automatic tightening device

When assembling a PHE, tightening must be performed with uniform tightening force. Use of an automatic tightening device allows assembly in a short time with the ideal balance of tightening force.



High temperature and pressure Hot Water Jet Cleaning

This cleaning method is applied to the plates which are used for duties of quenching oil and lubricant oil. 120°C and 14 MPa hot water makes a boiling effect when shooting from the nozzle, and oil residues are blew out from the plate surface. The cleaning is shortened to 1/3 time with this method in comparison with a conventional method.

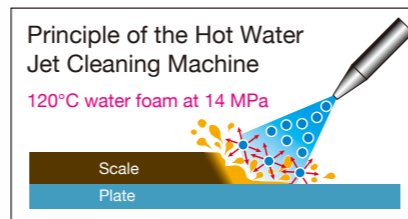

Comparison of Cleaning Results



The black areas are oil stains.



Hot Water Jet Cleaning



Maintenance at Customer's Site ②

Cleaning In Place (CIP)

Disassembling and cleaning a PHE makes it possible to remove hard scale and clogging matters and to recover performance to nearly the same level as new. However, if disassembly and cleaning are not possible, HISAKA offers CIP using Plate-Clean at the customer's site.

Before scaling, CIP with Plate-Clean can restore performance by removing scale through washing and dissolving. This is effective in prolonging the disassembly cleaning cycle of the PHE.

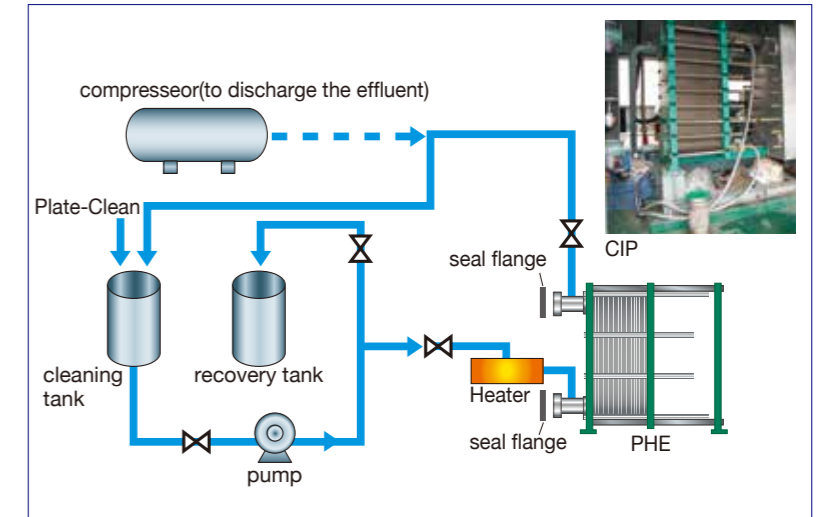

Schematic diagram of CIP

•Cleaning Effect Examples 1

As shown in the photo below, we conducted a test in which a plate with seawater scale underwent circulation cleaning with Plate-Clean. As a result of cleaning with Plate-Clean, the scale was satisfactorily removed through washing and dissolving.



•Cleaning Effect Examples 2

The data below was taken from an example of cleaning work performed using Plate-Clean in a PHE that used seawater as the coolant. Before cleaning, the plates tubes had narrowed and pressure loss increased due to scale growing inside the equipment. Also, the cooling effect had diminished. After cleaning, the seawater-side pressure loss diminished, and the cooling effect recovered by 43%.

	Pressure Loss (Mpa)	Temp Ctrl Valve Opening (%)	Heat Transfer Performance * 100 = Before cleaning
Before Cleaning	0.11	100	100
After Cleaning	0.06	70	143

* Complete cleaning is not guaranteed.

•Plate-Clean

Plate-Clean is a special cleaner for PHEs. By circulating the cleaner inside the PHE, stubborn scale that forms on the cooling water, warm water, and steam sides can be easily removed by cleaning and dissolving without disassembling the unit. Customers are no longer required to perform the hard work of removing scale.

Cleaner and Target Scale

	Product Name	Target Scale
Cleaner	Plate-Clean C	Calcium carbonate
	Plate-Clean S	Slime, mud
	Plate-Clean F	Iron rust

Plate-Clean Series



Plate-Clean C Plate-Clean S Plate-Clean F

* Each type of Plate-Clean is also sold separately.



Spare Parts for Maintenance

Every plate and gasket is available for purchase, for customers who would like to perform maintenance on their own. We also provide all other PHE parts that can be replaced, such as tightening bolts and nuts, rubber boots, frames, and nozzles. Please contact HISAKA or a nearby distributor about maintenance.

Gaskets

Periodical replacement is recommended. For more information about regasketing, refer to the "Operation and Maintenance Manual" and the "Gasketing Manual".

Plate Gasket

This gasket is used for plates. The material used differs depending on use. There are two types of gaskets: one is a glue type and the other is a glue free (slit-in) type.

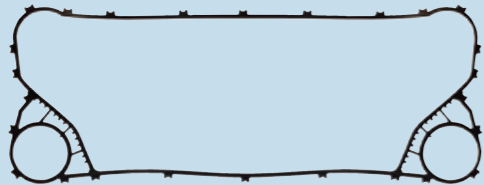

D-Plate Gasket

This gasket is for the D-plate, which prevents fluids from contact with the S-frame. It consists of a ring shaped gasket that seals fluids and a distance piece gasket as a cushion. The material used differs depending on use.

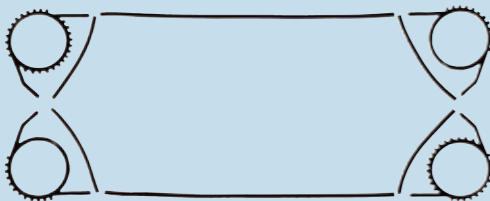

E-Plate Gasket

This gasket is installed on the E-plate, a plate without port holes and which prevents fluids from contact with the E-frame, and acts as a cushion. A plate gasket is installed on the channel side that contacts with fluids, and therefore both an E-plate gasket and an E-distance piece are installed on the E-plate.



Regasket Period

Since PHE gaskets are made of elastic rubber, it is not necessary to replace them every time the plate is disassembled. However, after many years of use they will deteriorate, harden, and lose their elasticity, resulting in a loss of sealing performance. Periodical regasketing is recommended.

Usage Temperature	Gasket Replacement Estimate
Hot water over 100°C	1 to 3 years
Warm water over 30°C and below 100°C	5 to 7 years
Water below 30°C	7 to 10 years

Note: For high-temperature uses such as steam heating and heat exchange uses such as fluids that are strongly corrosive to rubber, life time is shorter than the figures shown in this table.

Plates

Plates include a D-plate on the S-frame side and an E-plate on the E-frame side. The material used differs depending on use. As E-plate is only one plate in the unit, the spare plate in stock is recommended.

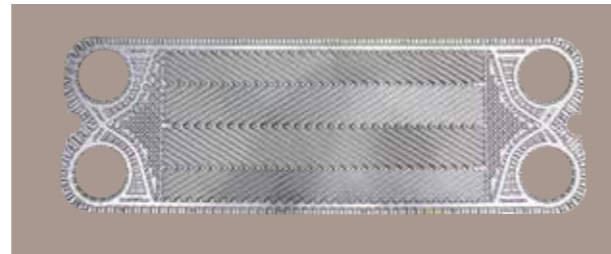

Tightening Bolt and Nut

Dimensions might differ depending on PHE model and the number used.



Adhesives



Rubber Boot for Connection

The rubber type only. Size and material might differ depending on PHE model and use.

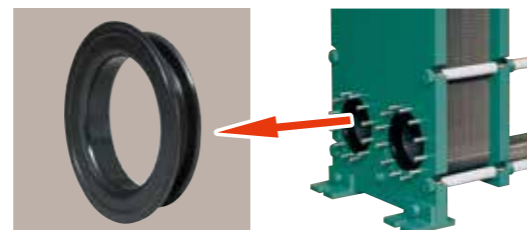

Other Service Options

Performance Check Service

Visualization of Diagnosis about Performance

Maintenance, When?

Preventing Loss of Heat Energy and Pump Power

Over long periods of operation, scale gradually forms on the heat transfer surface, eventually resulting in a reduction in heat transfer performance and an increase in a pressure drop. When the heat transfer performance drops below the design values, it can be restored to the original performance by performing maintenance. Decreasing of heat transfer performance and an increase in a pressure drop will lead to a reduction in heating, cooling, and heat recovery, and a loss of heat energy and pump power.

Pressure Loss and Heat Transfer Performance

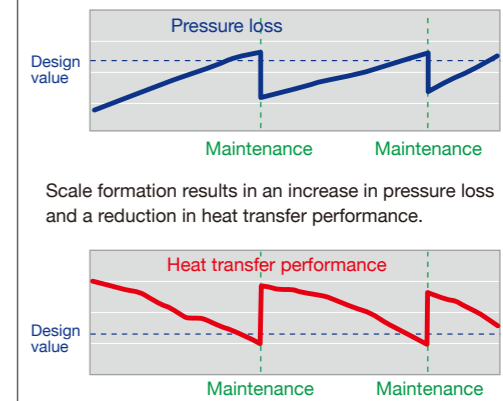

What is a Performance Check Service?

A detector is installed on the piping connected to the PHE to easily and quickly measure the performance of the PHE. Based on the results of this diagnosis, an estimate of the optimal maintenance period is estimated and the performance restored after cleaning is visualized.

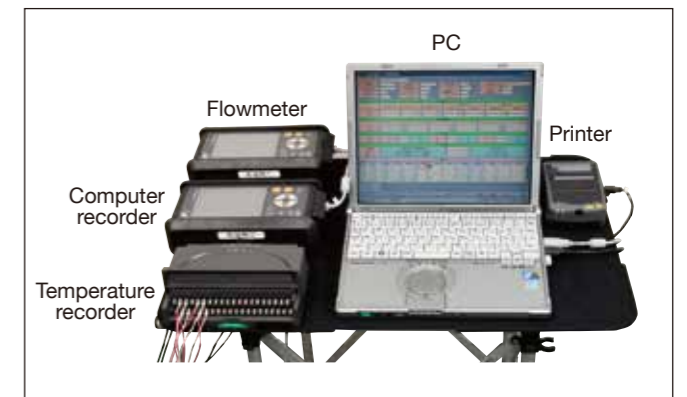

Re-Pressing Plates

After long operation of PHEs, strain and deformation can occur in PHEs. HISAKA offers a re-press service for the plates in operation at the site. Through this re-press service, plates can be restored. (Depending on model and the condition of the plates you are using, the re-press service might not be available. Contact HISAKA in advance for more information.)



Plate dies for re-pressing



Plate Rotation System



Simple Replacement with Maintained Plates

- Based on the contract with the customer, HISAKA keeps the customer's plates in storage,
 - and uses these plates to quickly replace plates that are currently in use when maintenance is required.
 - The plates that are removed are maintained at a HISAKA service center,
 - and keeps the customer's plates in storage until they are required for maintenance the next time.
- This service can shorten time for on-site maintenance according to the operating schedule and can plan shortening of the operation downtime.



Advantages of Plate Rotation

Merit 1
Shorter Maintenance Time

HISAKA simply replaces the plates you are currently using with your plates that we keep in storage. We also provide on-site maintenance by our service engineers for plate disassembly, removal, assembly, and tightening.

Merit 2
Less Space and Fewer Personnel for Cleaning and Regasketing

As removed plates are sent to a HISAKA service center for maintenance, there is no need for space and personnel to perform maintenance on site. When maintenance is complete, the plates are stored at our service center until the next maintenance request.

Merit 3
Reliability and Safety by Maintained Plates Storage

Maintenance is performed by skilled professionals, and therefore pinholes and cracks are not missed. When defects are found on plates, not only gaskets but also plates can be easily replaced when necessary.

Merit 4
Replace Plates at Any Port

Plates in storage can be sent to anywhere according to the maintenance location and schedule even such as to ships/vessels.



PHE Model Description and Construction

PHE Model Description

The plate type, thickness, and number, and the frame model for HISAKA PHEs are indicated as shown below.

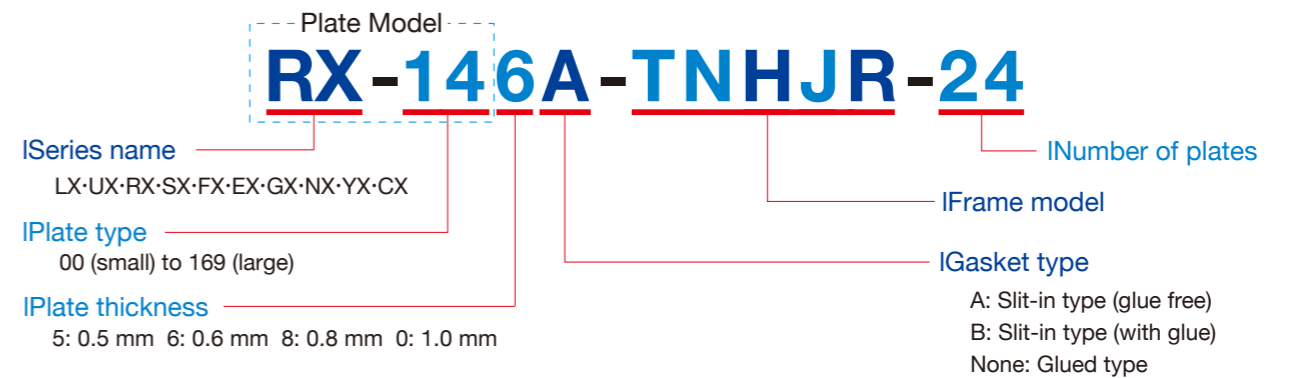

Construction of Plate Heat Exchanger (For 1 pass structure)

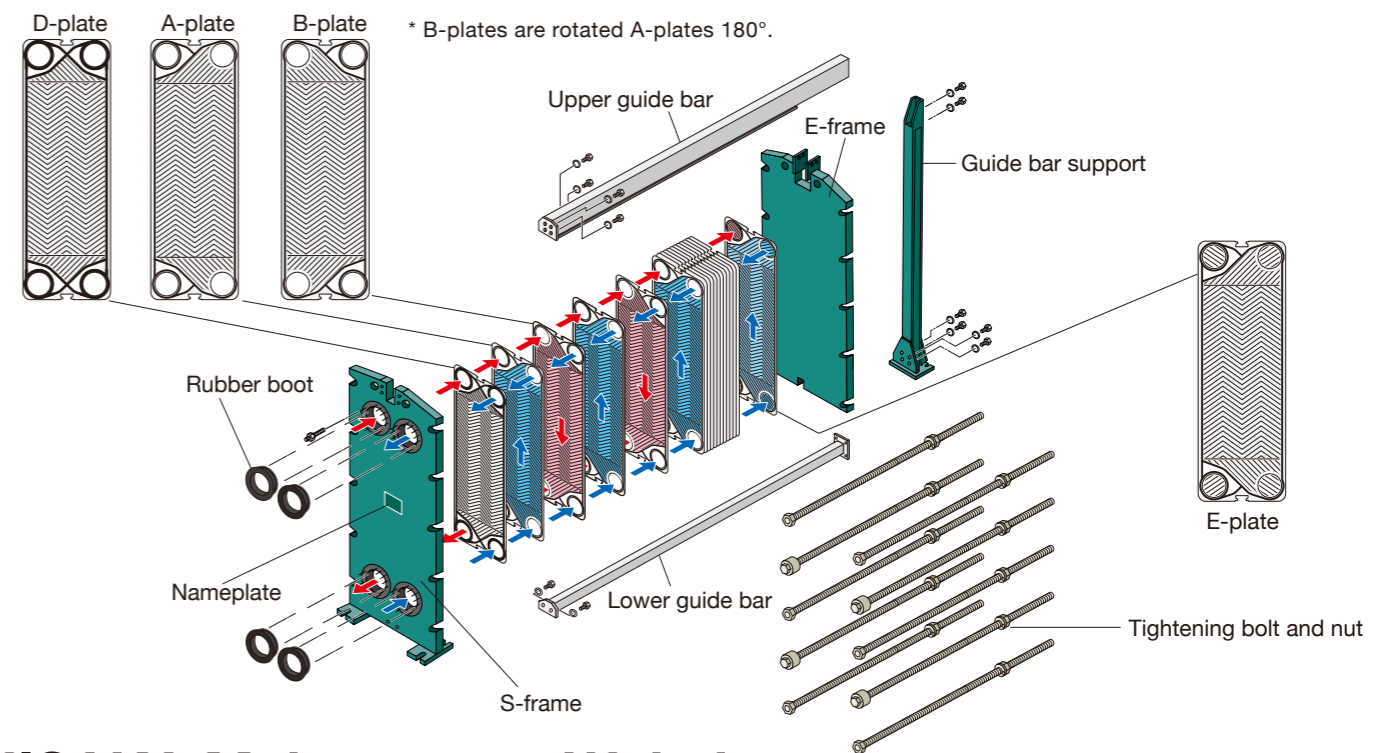

HISAKA Maintenance Website

HISAKA provides a website where you can understand the maintenance of your PHE.

The maintenance is a proactive action for unpredictable trouble. Please see the HISAKA website where you can understand the maintenance of your PHE.
Maintenance Website URL:
<http://www.hisaka.co.jp/english/support/heatexchanger/index.html>



Top Page on the Maintenance Website

Quotation Request Form

Osaka FAX: +81-6-6363-0161

"*" marked items are mandatory.

Serial No.* <small>Refer to the nameplate on your product.</small>		Model* <small>Refer to the nameplate on your product.</small>	
Maintenance Details	Full Service Package	<input type="checkbox"/> Full unit	<input type="checkbox"/> Plates only
	Maintenance at Customer's Site	<input type="checkbox"/> On-site maintenance	<input type="checkbox"/> CIP
	Purchase of Maintenance Parts	<input type="checkbox"/> Gasket For _____ units For plate No. _____ <input type="checkbox"/> Plates For _____ units For plate No. _____ <input type="checkbox"/> Glue (for general application / food application) (1ℓ, 200 cc): _____ cans <input type="checkbox"/> Double-sided tape: _____ rolls <input type="checkbox"/> Tightening bolts and nuts: _____ sets <input type="checkbox"/> Connecting rubber boots: _____ sets	
Additional Requests			
Company Name*			
Name*		Department/Division	
Address*			
TEL Number*		Email Address*	

Confirmation Items

Before sending this form, please confirm the following items on the PHE.

1. PHE Condition Check Sheet

Please check the PHE to be restored. If there are any leakage, place a check mark on the figures below at the location of the leaks.

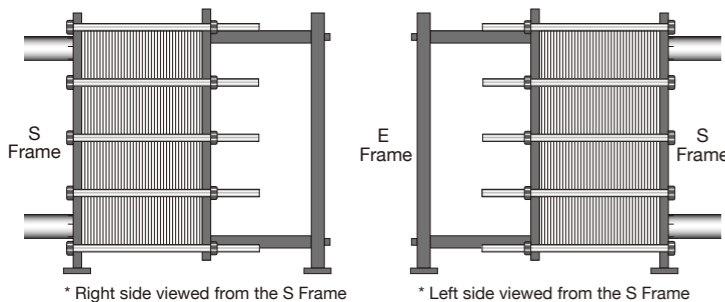

Rust, deterioration, etc. of tightening bolts	Yes	No
Date of previous maintenance		

2. Check List for Maintenance at Customer's Site

1. Installation location (address)			
2. Space around PHE (1 m each side)	Yes	No	
3. Distance to water jet area	1 m to 20 m	More than 20 m	
	Stairs	Yes (_____ floors)	No
	Elevator	Yes	No
4. PHE and piping with drain pipe	Yes	No	
5. Available utility	Power supply	Yes (100 V or 200 V)	No
	Compressed air	Yes	No
	Water	Yes	No
	Ratchet spanner	Yes	No
6. Distance to utility	1 m to 30 m	More than 30 m	
7. Outfit to be needed for work at your site	Safety belt	Protective eyewear	Gaiters
	Overshoes	Tyvek	Other (_____)
8. Safety education	Yes	No	
	Start time of work (_____ : _____)		



Global Service Network

Maintenance Service for PHEs by Manufacturer is global standard.

HISAKA is expanding its service centers both in Japan and overseas in order to provide quick and high-quality maintenance services to our PHE customers. Our professional work performed at our service centers has received high marks from our customers. 100% of our Full Service Package customers is a repeater.

Today, manufacturer service is the standard for PHE maintenance.

About Maintenance for PHEs:

Customer Service

TEL: +81-72-966-9601

FAX: +81-72-966-8923

Please be sure to give us the serial number for inquiry.

Global Maintenance Network

HISAKA is rapidly expanding its service centers overseas, building a global service network. HISAKA provides its "Full Service Package" in Malaysia, China, Thailand, Singapore, and Saudi Arabia. This service has received high marks from our overseas customers. HISAKA will continue to make further improvements to global expansion and its service network.

Domestic Service Centers:

- **Heat Exchanger Division, Konoike Plant**
2-1-48 Higashi-konoike-cho, Higashi-Osaka City, Osaka 578-0973 Japan
TEL:+81-72-966-9601
- **New Kanto Service Center**
815-1 Imazayasayama, Ichihara City, Chiba 299-0106 Japan
TEL:+81-436-98-5231
- **Chugoku/Shikoku Service Center**
2-8 Mizushima-myojin-cho, Kurashiki City, Okayama 712-8003 Japan
TEL:+81-86-446-4424
- **Kyushu Service Center**
1-1-4 Hanatakamatsu, Oita City, Oita 870-0915 Japan
TEL:+81-97-556-6400

Overseas Maintenance Inquiries:

- **HISAKAWORKS S.E.A. SDN. BHD. (Malaysia)**
TEL: +60-3-58804185
- **HISAKA WORKS (THAILAND) CO., LTD. (Thailand)**
TEL: +66-2-744-3287
- **HISAKAWORKS SINGAPORE PTE. LTD. (Singapore)**
TEL: +65-6-897-8489
- **PT. HISAKA WORKS INDONESIA (Indonesia)**
TEL: +62-21-2931-9235
- **HISAKA WORKS (CHINA) CO., LTD. (China)**
TEL: +86-512-5213-3000
- **HISAKA MIDDLE EAST CO., LTD. (Saudi Arabia)**
TEL: +966-13-838-4700