

HISAKA

Brazed Plate Heat Exchanger Instruction Manual for BX Series

Thank you for purchasing Hisaka Brazed Heat Exchanger.

- Read carefully this instruction manual to use the heat exchanger properly and safely.
- To ensure safety, please read this instruction carefully before using the heat exchanger.
- Fill in the BHE model, manufacturing number, and the date of delivery in the product warranty (page 11).
- Keep this instruction manual and the product warranty with care.
- You can download the Instruction Manual (PDF format) from the website.
<https://www.hisaka.co.jp/english/phe/cgi-other/catalog/49/file.pdf>



Brazed Plate Heat Exchanger Instruction Manual

Table of Contents

Safety Precautions	3
1. Structure of Brazed Plate Heat Exchanger	6
2. Unpacking and Before Installing	7
3. Operating Precautions	7
4. Storage/Installation Environment	8
5. Installation	8
6. Fixing Methods	9
7. Piping	9
8. Operation	9
9. Maintenance	10
10. Warranty	11

Safety Precautions

Before using Brazed Plate Heat Exchanger (hereafter BHE), read carefully the following precautions to use BHE properly.

Contact Hisaka Works for questions.

The precautions are classified under the following expressions.



WARNING

Indicates "A dangerous situation that could result in death or serious injury."



CAUTION

Indicates "A dangerous situation that could result in injury or material damage."

● Meaning of Symbols



This symbol indicates content where mishandling could result in death or serious injury.



Indicates "Prohibition (what must not be done)".



Indicates "Mandatory (what must be done)".



WARNING



Do not use as steam heater.

Repetition of heating and cooling may break BHE, causing steam to blow out.



Do not use fluid that causes corrosion of BHE.

Corrosion and erosion can result in the outpouring of fluid from BHE.



Set the warning indication when using BHE for high-temperature, high-pressure, or dangerous fluid (caustic soda, ammonia, or the like).

Establish awareness that outpouring of internal fluid may lead to an accident causing death or serious injury.



To avoid outpouring of internal fluid, observe the following precautions when loosening the connections of equipments or piping.

- Confirm that operation must be stopped.
- Confirm that BHE internal pressure drops to zero.
- Confirm that BHE surface temperature drops to room temperature.



CAUTION



Water remains inside after submerging test or hydro-pressure test.

If process fluid is not allowed to be in contact with water, avoid submerging test or hydro-pressure test.

Inevitably, in case of performing the submerging test or hydro-pressure test, after test, dry sufficiently the inside and outside of BHE.



Use gloves and arm coverings resistant to cutting when handling or operating BHE.

The sharp edges of the plate can cut hands or arms.



Do not touch BHE during or immediately after operation.

Touching BHE with high temperature can result in being burnt or frostbitten.

Safety Precautions

CAUTION



Do not operate BHE beyond its specified conditions (temperature, flow rate, and pressure).

Deformation of heat transfer plates, leakage and unable to achieve requested performance might happen.



In case of using BHE as a heater, watch/control the operating condition to avoid the scorching on the plates by:

- When starting operation, flow the cold fluid first, and then the hot fluid.
- When stopping operation, stop the hot fluid first, and then the cold fluid.



To prevent the fluid from freezing between the heat transfer plates.

- When starting operation, flow the hot fluid first, and then the cold fluid.
- When stopping operation, stop the cold fluid first, and then the hot fluid.



Avoid any load on the nozzles of BHE. The nozzles can be damaged by the load.

BHE itself or BHE nozzle might be damaged by a load from the piping/the control devices or a load by thermal expansion of piping.
Support the piping to offset the load.



Avoid any vibration on BHE.

BHE itself or BHE nozzle might be damaged by a vibration. When installing and fixing BHE, take appropriate measures such as providing support or suppressing the vibration.



Avoid any pressure shock to BHE.

The pressure shock can cause deformation or cracking or leakage of BHE.



Do not install on any heat-generating equipment.

BHE might be deformed by heat, and unable to achieve requested performance.



Use only the cleaning chemicals recommended in Section 9 "Maintenance" (on page 10).

Any cleaning chemicals except the recommended may corrode BHE.



Do not use the cleaning chemicals frequently.

Use it only in case of decreasing the performance.
Frequent use may cause corrosion of BHE.



The durability of BHE can drop significantly in the operating conditions as shown below. Contact Hisaka Works to check that BHE can be used.

- Operation where the temperature difference of the hot fluid inlet and cold fluid inlet exceeds 80°C
- Operation where there are frequent pressure fluctuations (pressure shock)



BHE should be used vertical installation for evaporator or condenser.

Sufficient performance may not be obtained other than vertical installation.



Install the control devices such as a solenoid valve at inlet side of the flow channel.

If installing them at the outlet side, BHE may be damaged by pressure shock.



Install a strainer of mesh size 10 to 20 at the inlet side of BHE.

It is effective to prevent the clogging of BHE.

Safety Precautions



CAUTION

Flow directions are as follows:.



- Refrigerant such a chlorofluorocarbons or ammonia on the primary side.
(Design pressure of the primary and secondary sides might differ depending on the model.)
- Upward for vaporized fluid such a refrigerant .
- Downward vapor and/or Gas to be condensed.
- If using for liquid-liquid applications, the fluid with a smaller temperature change should be on the secondary side.
- Upward for fluids with high viscosity.



In the case of copper-brazed material, pay attention to the components of the chemicals.
Depending on the chemicals used, copper may be eluted, resulting in a significant reduction in durability.



When cleaning the inside of BHE, keep the temperature difference as small as possible during the cleaning process.
Repetition of rapid temperature change during cleaning may damage BHE.



If performing the leak test, pressurizing for a one side and the other side should be in atmospheric condition.
If the test pressure is applied to both sides at the same time, any leakage cannot be detected.



If performing the pneumatic test for one side, by submerging more than 5 minutes in the water, release air sufficiently from the other none-pressurized side.
If air is not sufficiently release, the remaining air might be confused as air leakage from pressured side.

1. Structure of Brazed Plate Heat Exchanger

BHE consists of an S frame, heat transfer plates and E-frame as shown in the structural diagram on the below. These components are brazed by copper and nickel materials.

●BHE Structure

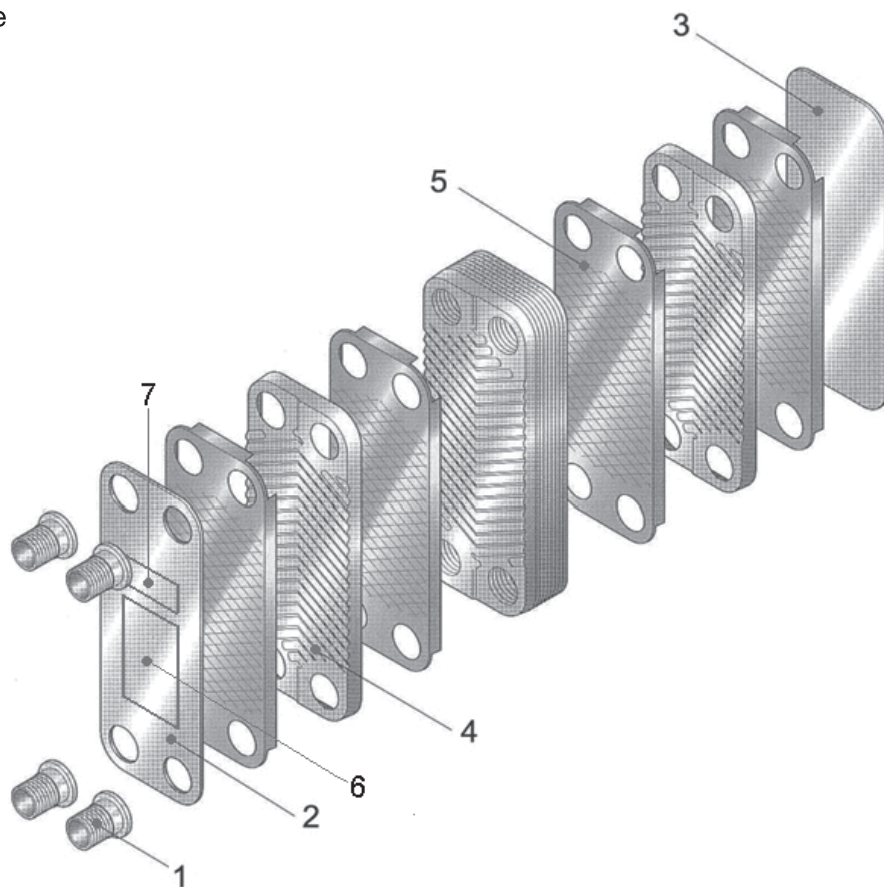

No.	Part Name	Comment
1	Outlet/Inlet nozzle	Shapes vary according to application.
2	S frame	Shapes vary according to application.
3	E frame	Some models do not have an S frame and/or E frame.
4	Heat transfer plate	Cannot be disassembled due to brazing.
5	Brazed material	Can be selected from copper or nickel materials.
6	Name Plate label	Indication of BHE model and specifications
7	Manufacturing number	Serial number of BHE Some models indicate this on E frame or plate.

Brazed copper and nickel have the following characteristics.

●Copper Brazed

Copper is an efficient bonding method for many industries like automotive and refrigeration. Copper brazed heat exchanger is used for evaporator, condenser of refrigerant in the compression refrigeration cycle and heater of hot water supply.

●Nickel Brazed

Nickel has special feature for corrosion resistance.

Nickel brazed heat exchanger is used for such as aqueous solutions of lithium bromide of absorption chillers, fluid of ammonia chillers, and for purified water with a contamination problem caused by elution of copper ions.

2. Before Using BHE

- Open the delivered package, and confirm the followings:
 - Check the name plate label on BHE to check that the delivered product is as ordered.
 - Check that there is no damage on BHE.
 - Check that all accessories, if ordered, are included.
Fixing brackets and mounting brackets are option, and normally not included.
Please prepare them by yourself.

If the delivered goods is not as ordered, found damaged, or if accessories are missing, please contact Sales Dept., Heat Exchanger Div. of Hisaka Works,Ltd.

- Keep this instruction manual with care after reading it.
When reselling or transferring BHE, or when selling it as incorporated in another equipment, be sure to attach this instruction manual.
-

- Read the instruction manuals carefully about devices to be connected to BHE.
Pay attention also to the characteristics and handling instructions of fluids to be used.
-

- Strictly observe all laws and regulations corresponding to any other machinery/equipment connected to BHE, and fluids that are used in each country where BHE is used.
-

- This manual is written in English and the customer must accept full responsibility for their thorough understanding of the contents of this manual.
-

- The copyrights of this manual are owned by Hisaka Works, Ltd.
-

- If there are questions regarding the contents of this manual and BHE, contact Sales Dept., Heat Exchanger Division of Hisaka Works, Ltd
-

3. Operating Precautions

- BHE performs heat transfer by two fluids with a difference of temperature through individual channels separated through plate.

It can be highly efficient heat transfer from hot fluid to cold fluid. BHE is used as heater, cooler, evaporator, and condenser.

Do not use BHE for other purposes.

- Be sure to fix BHE with reference to the fixing method examples shown in Section 6 "Fixing Methods" (page 9). Brackets for fixing BHE are normally not included. Please prepare them by yourself.
-

- Work with a suitable piping connection and method for the model of BHE.



Read Section 7 "Piping" (page 9) for details.

4. Storage/Installation Environment

- Storage/installation environment must be considered so that BHE is free from deformation, rust and corrosion.
 - Ambient environment: Avoid hot, humid, or freezing environment; do not place any object on BHE; and so forth.
 - Ambient temperature : -35°C to $+80^{\circ}\text{C}$
 - Ambient humidity : Relative humidity: 30% to 95% RH (no condensation)

5. Installation

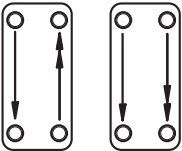
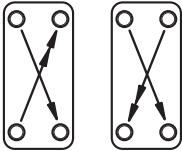
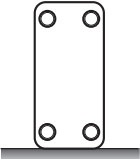
- Use BHE in the installation orientation indicated by "○" in the table below. If used in the orientation indicated by "×", BHE may suffer from problems such as fluid accumulation and drifting, resulting in damage or failure in obtaining sufficient performance.

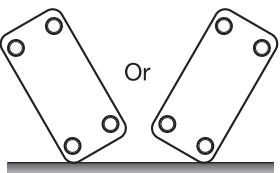
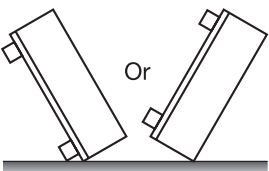
Flow direction of product Setting	 Parallel flow	 Diagonal flow
Vertical 	○	○
Horizontal 	×	○
Lying back 	×	×
Slanted① 	×	○
Slanted② 	×	×

6. Fixing Methods

- Read "Safety Precautions" (pages 3 to 5) carefully, and then fix BHE so that no load acts on BHE or the nozzles and no vibration acts to BHE.

- Fix BHE with reference to the fixing methods shown in the figure below.
Fixing brackets are normally not included. Please prepare them by yourself.

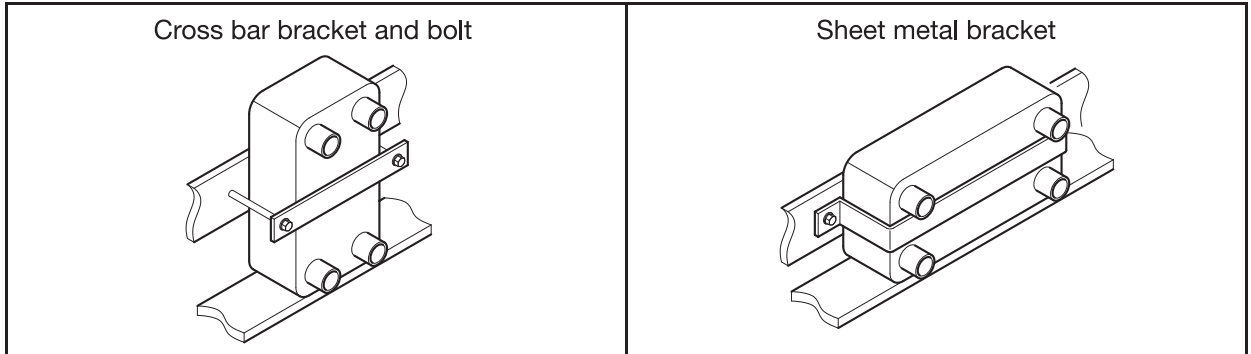

7. Piping

- Read the precautions carefully on how to let the fluid flow described in "Safety Precautions" (pages 3 to 5), and then connect the piping and the control devices.
- For information on the bore diameters and specifications of pipes connected to BHE, and on the fluid flow direction and connection ports, refer to the assembly drawing.
- If you need to change the fluid connection ports shown in the assembly drawing, contact Hisaka Works in advance, and check about the change.

8. Operation

- For the method and sequence of starting and stopping the operation, follow the precautions described in "Safety Precautions" (pages 3 to 5).
- Remove the air sufficiently for a while after starting the operation.
- There is a possibility that the fluid might freeze after stopping operation in the environments listed below.

- Cold regions
- As a cooler with a continuous flow of only low-temperature cooling medium.
- As a heater with a continuous flow of only low-temperature heating medium.

Discharge the fluid inside of BHE as soon as possible after stopping in order to prevent the fluid from freezing.

9. Maintenance

Periodical Maintenance

- Visually check that no abnormality is found in appearance of BHE.
If rust occurs or brazing material is eluted, leakage may occur. Replace a new unit of BHE.
- During maintenance, flush the fluid at a rate of 1.2 times or more of operating flow rate to discharge foreign materials from the inside of BHE. It can be more effective by feeding in the compressed air at the same time.

Maintenance for decreasing of Flow Rate or Heat Transfer Performance, or increasing Pressure Drop

- Remove BHE from the piping, and strongly blow compressed air or fresh water from the fluid outlet nozzles into BHE to flush out foreign materials from the inside.
- Remove BHE from the piping, and flow the chemicals from the primary or secondary nozzles to clean BHE. The following cleaning method is recommended.

Example of chemicals

	Aqueous Solution (Chemicals)
Acids	5% citric or oxalic acid aqueous solution
Alkalies	5% caustic soda aqueous solution

Cleaning Procedure

	Process	Explanation
1	Flushing	Flushing out for 20 to 40 minutes to completely replace the fluid with fresh water.
2	Acid cleaning	Circulate aqueous solution containing 5% citric acid or 5% oxalic acid at 30°C to 60°C for 30 to 60 minutes. * Adjust cleaning time so as to obtain an appropriate cleaning effect.
3	Flushing	Perform flushing for 20 to 40 minutes to completely replace detergent with fresh water.
4	Alkaline cleaning	Circulate aqueous solution containing 5% caustic soda at 30°C to 60°C for 30 to 60 minutes. * Adjust cleaning time so as to obtain an appropriate cleaning effect.
5	Flushing	Perform flushing for 20 to 40 minutes to completely replace detergent with fresh water.
6	Drying, disinfection, sterilization, etc.	Depending on your conditions of use, such as evaporator, condenser, oil cooler, or food equipment, provide processes such as a drying process, disinfection process, and sterilization process.

Cleaning Precautions

- For precautions in cleaning BHE, read "Safety Precautions" (pages 3 to 5).

Points to be noted in Cleaning

- In order to improve the cleaning effect, the cleaning flow rate should preferably be as much as possible. (Recommended flow rate: 1.2 times or more than operating flow rate)
- The cleaning-in-place (CIP) is normally performed by combining "acids" and "alkalies". However, depending on your conditions of use, select the chemicals which has higher cleaning effect.

Pressure Test and Leak Test

- For precautions in performing the pressure test or leak test of BHE, read "Safety Precautions" (pages 3 to 5).

10. Warranty

Hisaka Brazed Plate Heat Exchanger Product Warranty

BHE Model			
Manufacturing Number			
Date of Delivery	Year:	Month:	Day:

For BHE model name, see the name plate label or the assembly drawing.
The Manufacturing Number is indicated on the S frame or E frame or end plate.

■ Extent of Warranty

If any failure occurs in BHE while being used properly as a result of our manufacturing or engineering problem, HISAKA will deliver the substitute BHE for BHE being failure at our responsibility. The warranty covers the heat exchanger performance that Hisaka Works provides only as a single unit used under the conditions based on the design specification, and not as "equipment" in which BHE is incorporated.

■ Warranty Period

The warranty period is one year from the date of delivery of BHE.

■ Items Beyond Warranty

If the failure is caused by any of the following, it is not covered by the warranty even within the warranty period.

- Failure caused by your improper handling or supervision during construction work after delivery of BHE. (External damage of BHE, deformation or damage of nozzles by piping load or connection work, etc.)
- Failure caused by not observing the various items described in "Safety Precautions" (pages 3 to 5).
- Failure caused by using the product under conditions different from the design specifications.
- Failure caused by natural disaster such as earthquake or fire.

■ Exemption from Responsibility

Hisaka Works shall not be responsible for indirect damages caused by failure of this product. (Costs of system repair, cost of fluid, countermeasures, etc.)

■ Other

If you have special requirements other than the items listed in the assembly drawing and this instruction manual, please contact Hisaka Works.

■ Contact for Product Information

HISAKA WORKS, LTD., Heat Exchanger Div., Sales Department

Osaka Sales Section: Seiwa Umeda Bldg. 20th Floor, 2-12-7 Sonezaki, Kita-ku, Osaka City,
Osaka 530-0057 Japan

TEL: +81-6-6363-0020 FAX: +81-6-6363-0161

Tokyo Sales Section: Kyobashi OM Bldg. 2nd Floor, 1-19-8 Kyobashi, Chuo-ku,
Tokyo 104-0031 Japan

TEL: +81-3-5250-0760 FAX: +81-3-3562-2759

Nagoya Sales Section: Fujifilm Nagoya Bldg. 12th Floor, 1-12-17 Sakae, Naka-ku, Nagoya City,
Aichi 460-0008 Japan

TEL: +81-52-217-2491 FAX: +81-52-217-2494

URL <http://www.hisaka.co.jp/english/phe/>

E-Mail heatexc@hisaka.co.jp



HISAKA WORKS, LTD. HEAT EXCHANGER DIVISION

**HISAKA WORKS, LTD., Heat Exchanger Division acquires both
ISO9001 and ISO14001 certification.**

HISAKA WORKS, LTD., Konoike Plant acquires ISO45001 certification.